

# **Network Fixed Dome Cameras**

## Quick Guide

Manual Version:V1.01

Thank you for purchasing our product. If there are any questions, or requests, please do not hesitate to contact the dealer.

## Copyright

Copyright 2015 Zhejiang Uniview Technologies Co., Ltd. All rights reserved. No part of this manual may be copied, reproduced, translated, or distributed in any form or by any means without prior consent in writing from our company.

## Trademark Acknowledgement

 and other Uniview's trademarks and logos are the property of Zhejiang Uniview Technologies Co., Ltd. Other trademarks, company names and product names contained in this manual are the property of their respective owners.

## Disclaimer



The default password is used for your first login. To ensure account security, please change the password after your first login. You are recommended to set a strong password (no less than eight characters).

- To the maximum extent permitted by applicable law, the product described, with its hardware, software, firmware and documents, is provided on an "as is" basis.
- Best effort has been made to verify the integrity and correctness of the contents in this manual, but no statement, information, or recommendation in this manual shall constitute formal guarantee of any kind, expressed or implied. We shall not be held responsible for any technical or typographical errors in this manual. The contents of this manual are subject to change without prior notice. Update will be added to the new version of this manual.
- Use of this manual and product and the subsequent result shall be entirely on your own responsibility. In no event shall we be reliable to you for any special, consequential, incidental, or indirect damages, including, among others, damages for loss of business profits, business interruption, or loss of data or documentation, or product malfunction or

information leakage caused by cyber attack, hacking or virus in connection with the use of this product.

- Video and audio surveillance can be regulated by laws that vary from country to country. Check the law in your local region before using this product for surveillance purposes. We shall not be held responsible for any consequences resulting from illegal operations of the device.
- The illustrations in this manual are for reference only and may vary depending on the version or model. As a result, some of the examples and functions featured may differ from those displayed on your monitor.
- This manual is a guide for multiple product models and so it is not intended for any specific product.
- Due to uncertainties such as physical environment, discrepancy may exist between the actual values and reference values provided in this manual. The ultimate right to interpretation resides in our company.



## Environmental Protection

This product has been designed to comply with the requirements on environmental protection. For the proper storage, use and disposal of this product, national laws and regulations must be observed.



## Safety and Compliance Information

### Safety Symbols

The symbols in the following table may be found on installation-related equipment. Be aware of the situations indicated and take necessary safety precautions during equipment installation and maintenance.

Symbol	Description
	Generic alarm symbol: To suggest a general safety concern.
	ESD protection symbol: To suggest electrostatic-sensitive equipment.
	Electric shock symbol: To suggest a danger of high voltage.

The symbols in the following table may be found in this manual. Carefully follow the instructions indicated by the symbols to avoid hazardous situations and use the product properly.

Symbol	Description
	<b>WARNING!</b> Indicates a hazardous situation which, if not avoided, could result in bodily injury or death.
	<b>CAUTION!</b> Indicates a situation which, if not avoided, could result in damage, data loss or

Symbol	Description
	malfunction to product.
	<b>NOTE!</b> Indicates useful or supplemental information about the use of product.

## Safety Information

Installation and removal of the unit and its accessories must be carried out by qualified personnel. Please read all of the safety instructions below before installation and operation.

### Installation

- This device is a class A product and may cause radio interference. Take measures if necessary. If the product does not work properly, please contact your dealer. Never attempt to disassemble the camera yourself. (We shall not assume any responsibility for problems caused by unauthorized repair or maintenance.)
- Please make sure that the ceiling can support more than 50(N) Newton gravities if the camera is fixed to the ceiling.
- Make sure the power supply voltage is correct before using the camera.
- Do not drop the camera or subject it to physical shock.

- Do not touch sensor modules with fingers. If cleaning is necessary, use a clean cloth with a bit of ethanol and wipe it gently. If the camera will not be used for an extended period of time, put on the lens cap to protect the sensor from dirt.
- Do not aim the camera lens at the strong light such as sun or incandescent lamp. The strong light can cause fatal damage to the camera.
- The sensor may be burned out by a laser beam, so when any laser equipment is being used, make sure that the surface of the sensor not be exposed to the laser beam.
- While shipping, the camera should be packed in its original packing.
- Keep the device from pressure, vibration, and moisture during transportation, storage, and installation. Keep the device away from any source of vibration during installation.
- Use a power adapter or a PoE device that meets requirements. Otherwise, the device may be damaged.
- Keep the length of the power cable between the power adapter and the device within 1.5 meters, otherwise, the power voltage on the device may be lowered and may cause exception. If the power cable is not long enough, extend the part between the power adapter and the power supply.

- Disconnect power before you move the device. The device is instantly electrified when the power cable is plugged in.
- Do not move the device by lifting the tail cable.
- Do not cut the cables. Exposed cables can cause short circuit and damage the device.
- Use the power cable connector delivered with the device. Make sure the connector (clip) is in good condition and secured into place. Do not fully stretch the power cable, otherwise, the connector may loose or be disconnected due to vibration or shake.
- The end of the tail cable must be kept under good protection. Take waterproof measures to protect the tail cable, and keep away from water.
- Ensure that the high-level signal of the alarm input is not higher than 5 VDC when connecting the alarm input interface.
- During the process of transportation, special attention is required for the protection of the transparent dome cover to prevent friction, scratch and contamination, etc. In order to keep the cover clean, do not remove the protective film on the cover during mounting. After mounting is finished, remove the film before the device is powered on.



- Make sure that the ceiling or wall can bear the weight of your camera.
- As is often the case in the industry, dome covers tend to have static electricity. To prevent dust absorption by the static electricity, it is recommended to clean the dome cover surface with antistatic gloves after removing the protective film.
- Contact professionals for maintenance information. Do not attempt to dismantle the device by yourself.

## **Maintenance**

- If there is dust on the lens or the transparent dome cover, remove the dust gently using an oil-free brush or a rubber dust blowing ball.
- If there is grease on the lens, remove the grease using an oil-free cloth gently and then clean the lens in a circular spiral from the center outward using an oil-free cloth or a lens cleaning paper dipped with small amount of cleaning solution. If the problem persists, change another oil-free cloth or lens cleaning paper and clean the lens gently until it is removed.
- If there is grease or a dust stain on the transparent dome cover, clean the cover gently from the center outward using anti-static gloves or an oil-free cloth. If the problem persists, use anti-static gloves or an oil-free cloth dipped with

detergent and clean the dome cover or the glass surface gently until it is removed.

- Do not use organic solvents, such as benzene or ethanol when cleaning the transparent dome cover.



- Never look at the transmit laser while the power is on. Never look directly at the fiber ports and the fiber cable ends when they are powered on.
- Use of controls or adjustments to the performance or procedures other than those specified herein may result in hazardous laser emissions.

## Regulatory Compliance

### FCC Part 15

This equipment has been tested and found to comply with the limits for digital device, pursuant to part 15 of the FCC Rules. These limits are designed to provide reasonable protection against harmful interference when the equipment is operated in a

commercial environment. This equipment generates, uses, and can radiate radio frequency energy and, if not installed and used in accordance with the instruction manual, may cause harmful interference to radio communications. Operation of this equipment in a residential area is likely to cause harmful interference in which case the user will be required to correct the interference at his own expense.

This product complies with Part 15 of the FCC Rules. Operation is subject to the following two conditions:

1. This device may not cause harmful interference.
2. This device must accept any interference received, including interference that may cause undesired operation.

### LVD/EMC Directive



This product complies with the European Low Voltage Directive 2006/95/EC and EMC Directive 2004/108/EC.

## WEEE Directive–2002/96/EC



The product this manual refers to is covered by the Waste Electrical & Electronic Equipment (WEEE) Directive and must be disposed of in a responsible manner.

# Contents

---

<b>1 Packing List</b> .....	<b>1</b>
<b>2 Appearance</b> .....	<b>1</b>
Dimensions and Appearance .....	1
Cable Connection .....	2
Internal Structure.....	4
<b>3 Mount Your Camera</b> .....	<b>5</b>
Hardware Installation .....	5
Ceiling Mount.....	5
Start Your Camera .....	10
Waterproof Measures.....	11
Waterproof Components for an RJ45 Plug .....	11
Waterproof Tail Cable .....	13

<b>4 Set Your Camera over the LAN .....</b>	<b>16</b>
<b>5 Access Your Camera .....</b>	<b>17</b>
Access Through Web.....	17
Install the ActiveX .....	18

# 1 Packing List

---

Contact your local dealer if the package is damaged or incomplete. The attachments may vary with models, please see the actual model for details.

No.	Item	Quantity
1	Camera	1
2	User document	1
3	Accessory pack	1

# 2 Appearance

---

## Dimensions and Appearance

The following takes the infrared camera as an example. For the actual appearance, see the product.

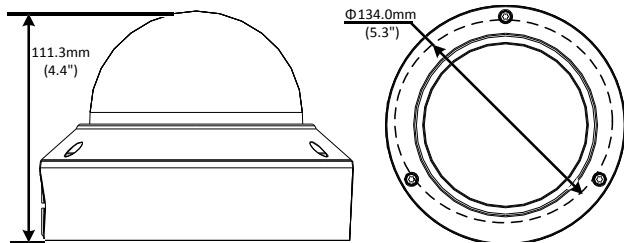

## Cable Connection

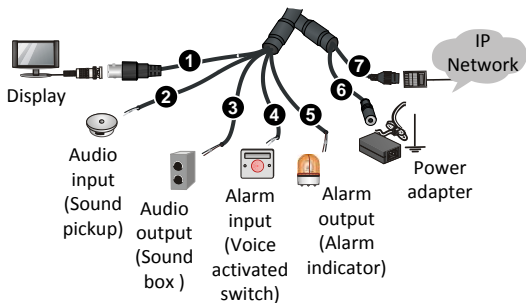



No.	Description	No.	Description
❶	Video output interface	❷	Audio input
❸	Audio output	❹	Alarm input
❺	Alarm output	❻	Power interface
❼	Network interface	-	-



- To protect the RJ45 plug from water, see [Waterproof Components for an RJ45 Plug](#).
- For specifications, see the latest product datasheets.

## Internal Structure

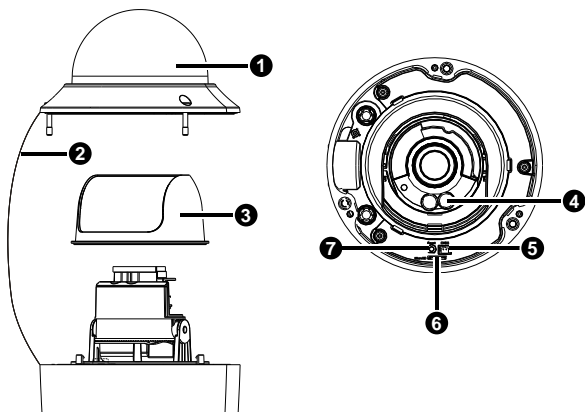

No.	Description	No.	Description
❶	Transparent dome cover	❷	Safety wire
❸	Inner cover	❹	Infrared light
❺	CVBS video output	❻	Micro SD card slot
❼	Reset button	-	-



Use a pin to press and hold the Reset button for about 15 seconds to restore factory default settings. Perform this operation within 10 minutes after the device is powered on or the reset will fail otherwise.

## 3 Mount Your Camera

---

### Hardware Installation

#### Ceiling Mount

The following part takes ceiling mount as an example. Wall mount is similar to ceiling mount and therefore is omitted here.

1. Locate the positions of the holes.

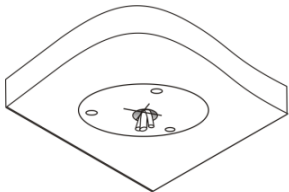

- 1 Paste installation positioning stickers on the ceiling.
- 2 Lead the cables through the hole on the wall.

**2. Drill holes on the ceiling.**

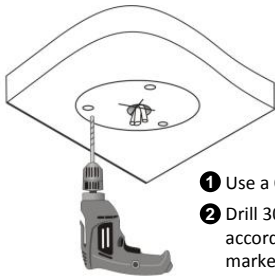

- 1** Use a  $\varnothing 6\text{mm}$ -6.5mm drill bit.
- 2** Drill 30 mm-depth guide holes according to the positions marked by stickers.

**3. Mount the plastic rivets of self-tapping screws.**

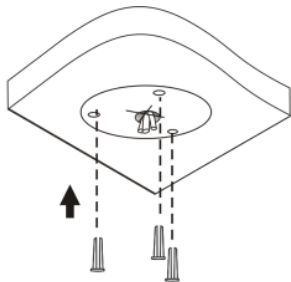

Knock the plastic rivets into the guide holes and ensure that they are tightened up.

#### 4. Mount your camera.

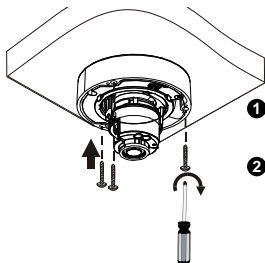

- 1 Connect all cables of the ceiling and your camera.
- 2 Lead self-tapping screws through the guide holes in the camera base, and fix your camera on the ceiling by using a screwdriver.

#### 5. Adjust the monitoring direction of the lens. Tighten the screws after vertically adjusting the lens.

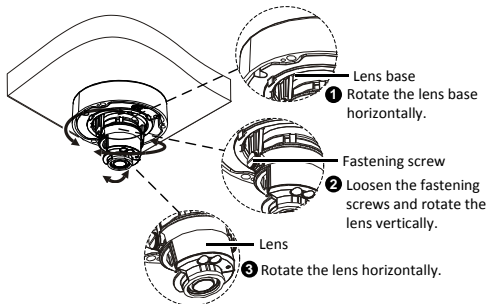



The above steps are only applied to the camera with manual zoom lens. For how to adjust the display of the camera with motorized zoom lens, please see the Web of the camera.

6. Attach the inner cover and lock it into the base buckle.

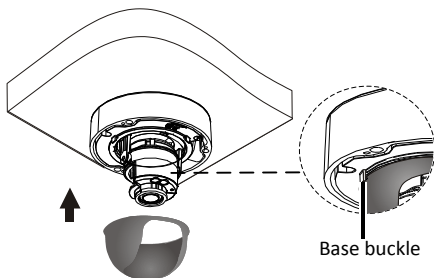

7. Inserting the Micro SD Card (Optional). Insert a SD card into the slot to use the local storage function. For detailed specifications of recommended SD cards, contact your dealer or technical support. Hot plugging is not recommended.

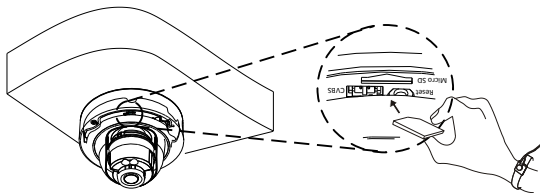

8. Mount the transparent dome cover.

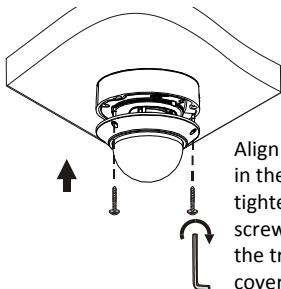

Align the screw holes in the base, and tighten the three torx screws on the edge of the transparent dome cover to fix it.



- The preceding installation process is concealed installation, during which holes are drilled in the ceiling and tail cable is led out from the top of your camera. Cables are connected and frapped at the ceiling side to prevent messy cables from affecting camera mounting. If open installation is adopted, tail cable is led out from one side of your camera and can be routed from the side groove of your camera.
- If necessary, wire the tail cables through pipes (for example 3/4 NPS threaded pipes), and screw the pipes into the threaded hole of the device to complete the connection.
- After mounting the dome cover, check that the three torx screws on the edge of the dome cover are tightened up to ensure that your camera is properly sealed. For details, see [Mount the transparent dome cover.](#)

## Start Your Camera

After verifying that your camera is properly mounted, connect the power cable to it and the other end of the cable to the mains. Then start your camera.



## Waterproof Measures

### Waterproof Components for an RJ45 Plug

1. Attach the seal ring to the network interface.

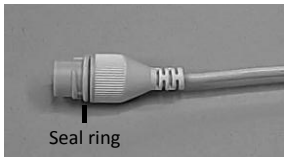

2. Mount the waterproof components.

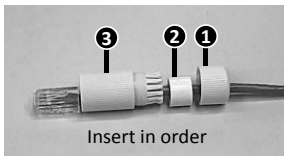

3. Insert the cylindrical waterproof ring into bolt.

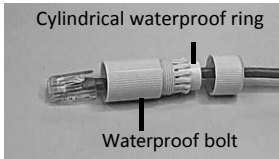

4. Insert the cable into the interface and screw the waterproof bolt in.



5. Screw in the waterproof bolt lid.



## 6. Finish the waterproof installation.

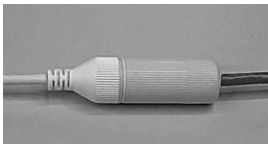

In step 2, you can crimp the inner wires of the cable with the RJ45 plug first and then cover the waterproof components. You may also cover the waterproof components first.

## Waterproof Tail Cable

Connect the tail cables and then take the following steps to protect the tail cables from water using waterproof tapes. The figures are for your reference only.

1. Connect the tail cables.

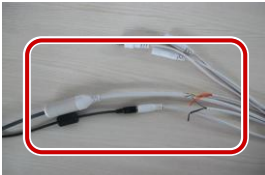

2. Protect the connected cables using insulating tapes.



3. Protect other cables using insulating tapes.



4. Wrap all the tail cables together using insulating tapes.



5. Choose a start point for waterproof tapes.



6. Protect the tail cables using waterproof tapes.





- Avoid short circuit when insulating the cables.
- Use self adhesive waterproof tapes that will stick together with the twisted cables.
- Tighten waterproof tapes when wrapping the cables and make sure the cable connections are fully covered.
- You are recommended to put the waterproof cables in a waterproof junction box which needs to be purchased separately.

## 4 Set Your Camera over the LAN

---

To view and configure your camera via a local area network (LAN), you need to install the EZStation to find your camera and change its IP address.



- Please contact your dealer to get the EZStation.
- Please refer to the user manual of EZStation for detailed information.

1. Connect your camera and your PC as shown in the figure below to ensure the routing is available.



2. Use EZStation to search online cameras automatically.
3. Modify your camera settings if necessary, including its IP address and subnet mask.



- The default IP address is “192.168.0.13”. The default username is “admin” and the default password is “123456”.
- To access your camera from a different subnet, set the gateway for your camera after you log in.

## 5 Access Your Camera

---

### Access Through Web

Before you begin, check that:

- Your camera is operating properly and connected to the network.

- The PC you are using is installed with Internet Explorer 7.0 or later. IE 8.0 is recommended.

Follow these steps to access your camera through the Web interface:

1. Open your browser, input the IP address of your camera (default IP is 192.168.0.13) in the address bar and then press **Enter** to open the login page.
2. Enter the username (default is “admin”) and password (default is “123456”) and then click **Login**.



Install the ActiveX at your first login. For the detailed steps, see [Install the ActiveX](#). When the installation of the ActiveX is completed, open your IE to log in.

## Install the ActiveX

The following takes the IE browser as an example to describe the installation steps.



1. Click **Download**.



Failed to load ActiveX control, click [Download](#) to install latest ActiveX control.

2. Click **Run** to install the downloaded ActiveX. You may also click **Save** to download the file to your computer first.
3. Close the browser and follow the steps to complete the installation.



- For your first login with Windows 7, if the system does not prompt you to install ActiveX, follow these steps to turn off UAC: click the **Start** button, and then click **Control Panel**. In the search box, type **uac**, and then click **Change User Account Control Settings**. Move the slider to the **Never Notify** position, and then click **OK**. After UAC is turned off, log in again.
- If the installation failed, open **Internet Option** in IE before login. Click the **Security** tab, click **Trusted sites**, and then click **Sites** to add the website. If you use Windows 7, you need to save the setup.exe to your PC first, and then right-click the file, select **Run as administrator**, and then install it according to instructions.

BOM: 3101C0C4